



## INSTRUCTION MANUAL

INTEGRATED AMPLIFIER

# EPILOG



# TABLE OF CONTENT

1. **PREFACE**
2. **General Description**
  - 2.1 Safety
  - 2.2 Installation
  - 2.3 Warranty and Service
3. **Operation**
  - 3.1 Front Panel Controls
  - 3.2 Connections – Rear Panel
  - 3.3 Quick Start Instructions
  - 3.4 Setup and Menu Structure
  - 3.5 Unity Gain
  - 3.6 EPILOG with DIRECTOR Remote Control
4. **Modules**
  - 4.1 UNBAL-INPUT Module
  - 4.2 BAL-INPUT Module
  - 4.3 UNBAL-OUTPUT Module
  - 4.4 BAL-OUTPUT Module
  - 4.5 PHONO-INPUT Module
  - 4.6 DIGITAL-INPUT Module
5. **What if...**
  - 5.1 ... nothing happens ?
  - 5.2 ... there's no sound ?
  - 5.3 ... it hums ?
  - 5.4 ... errors are made by man or machine?
6. **Specifications**

# 1. PREFACE

**Dear Customer,**

Thank you for choosing an **EPILOG** integrated amplifier. This product is manufactured with care under strict quality control and is a perfect example of state-of-the-art precision technology. Even if you are familiar with hi-fi equipment, please take a moment to study these instructions carefully and follow the instructions contained therein. Keep this manual for future reference; it is intended as a tool to help you make the best use of your new amplifier. Enjoy your new integrated amplifier!

Best wishes from your **TRIGON** - team.

## 2. GENERAL DESCRIPTION

**EPILOG** is an integrated amplifier that can be individually adjusted in the pre stages to the needs of the user by the use of modules. It can be inserted up to five modules in the back of the amplifier. Due to the modular design it is also possible to respond to the latest technical developments. The choices are unbalanced and balanced input modules, a phono module with MC / MM sensitivity, DAC module with two SPDIF Coax inputs, one optical input and a USB input and line output modules in symmetrical and asymmetrical design. The modules can be combined arbitrarily. The position in the slots can be freely selected. If necessary, a plurality of identical modules may be used. The modules offered will be expanded as new applications or technical progress requires. In these cases, not a completely new amplifier must immediately be purchased, but only the corresponding module.

So the **EPILOG** with comparatively little investment can always be kept up to date or be adapted to new requirements

In the class AB output stages of the so-called double mono principle each channel gets its own transformer and its own electrolytic capacitor package. In this manner, the mutual interference between the stereo channels is reduced to a minimum.

The bandwidth of the amplifier is very well designed to allow a time accurate transmission of all frequencies up to the upper limit of hearing. This is made possible by the use of symmetrical cascode amplifiers and measured pairs of bipolar power transistors. Each channel used six couples. Therefore **EPILOG** is able to drive speakers with a minimum impedance of 2 Ohm.

Always wakes sensitive safety electronics to the welfare of speakers and amplifiers. A dimmable turn off and on display at the front informed about the currently operating conditions.

The operation of the device can be done either manually directly at the Epilogue or with the IR Remote Control Director. Together with our network multimedia player

**CHRONOLOG** it is also possible to operate the **EPILOG** with a tablet computer or a smart phone.

From time to time it may be necessary to update the control software contained in this basic unit. On the rear panel is for this purpose a USB socket (26) to which you or your dealer can connect a computer to load the latest firmware into the memory of the integrated amplifier. This software is provided for free on our website. Software updates will always be necessary, if a newly developed module is to be operated, which did not even exist when buying the **EPILOG**. In the Info menu of the **EPILOG** the currently version can be read. On our website you can then check whether your device already has the latest software, or whether an update is needed.

The massive cabinet of the **EPILOG** consists of 2mm sheet steel and solid aluminum of various thicknesses. The cover, for example, consists of a sandwich of steel and aluminum and is in the important frequency range acoustically "dead".

Due to the complex cabinet construction sound may be best avoided by microphonics.

## 2.1 Safety

**TRIGON ELEKTRONIK GMBH** assumes no liability for any damage caused by improper handling, or failure to follow safety instructions.

Amplifiers must not be installed in close proximity to heat sources such as radiators, stoves, high power light sources, open flames, etc... and should not be exposed to severe shocks or vibrations.

Do not connect any electronic device to AC mains immediately after transport from the cold into a warm environment. Condensation may occur and cause damage to the device. Please wait until the unit has reached room temperature.

The amplifier should not be exposed to direct sunlight.

Make sure to install the unit with enough space for proper ventilation.

Never operate the equipment without the protective housing cover. Before opening the unit remove the AC plug from the socket.

Never attempt to bypass the fuse. Please replace a blown fuse only with a fuse of the same type and value.

No user serviceable parts inside. All maintenance or repair must be performed by authorized and specially trained personnel only. Tampering and damage caused by improper use or unauthorized intervention will void warranty.

Please turn amplifier off before connecting cables and/or other components.

The mains voltage must be between 100V and 240V AC.

Use only attachments and accessories specified by the manufacturer and intended for this purpose.

To clean the cabinet, use only a damp cloth if possible. Do not use corrosive or abrasive cleaning fluids. Unplug the unit before cleaning. Be careful not to accidentally damage or loosen any wiring when cleaning. Check all connections for proper fit before re-connecting the **EPILOG** to the grid.

**WARNING!** Always make sure that no liquids enter the interior of the device!

## 2.2 Setup

After unpacking, first check the equipment for shipping damage. If you notice any damage, please immediately contact your dealer. Then check the contents of two boxes to be complete.

You should see, besides the EPILOG:

- one **EPILOG** instruction manual -
- one warranty registration form -
- one module removal tool -

The amplifier should be installed level and in a dry location. Always ensure good ventilation. Please be aware that strong magnetic fields, such as caused by halogen or fluorescent light transformers can cause hum – it is recommended to keep a minimum distance of 1m (3'). Avoid direct sunlight and proximity to heat sources.

## 2.3 Warranty and Service

By choosing the **EPILOG** integrated amplifier, you have purchased a high quality and technologically advanced product. In order to meet TRIGON's requirements, every product must undergo numerous quality tests in every stage of production and a rigorous outgoing inspection. Furthermore, TRIGON ELECTRONICS GmbH offers a limited 3-year warranty on all products. This warranty covers the repair or replacement of defective components. Warranty repair is usually done at the factory. Further claims are excluded.

The warranty excludes all damage caused by improper installation, improper operation or resulting from repairs by unauthorized dealers and/or individuals. Furthermore, this warranty does not cover units with obliterated or missing serial numbers. Likewise, shipping damage or damage caused by accidents is not covered under warranty.

Please make sure to complete the included warranty card. The 3-year warranty period starts from the date of delivery by the dealer. Keep the warranty card and proof of purchase.

### 3. Before You Begin

After unpacking the preamp and power supply, both components should be allowed warm up to ambient temperature. Especially during the cold season humidity may form inside a component as it is moved from the cold to a warm environment.

#### EPILOG Front View

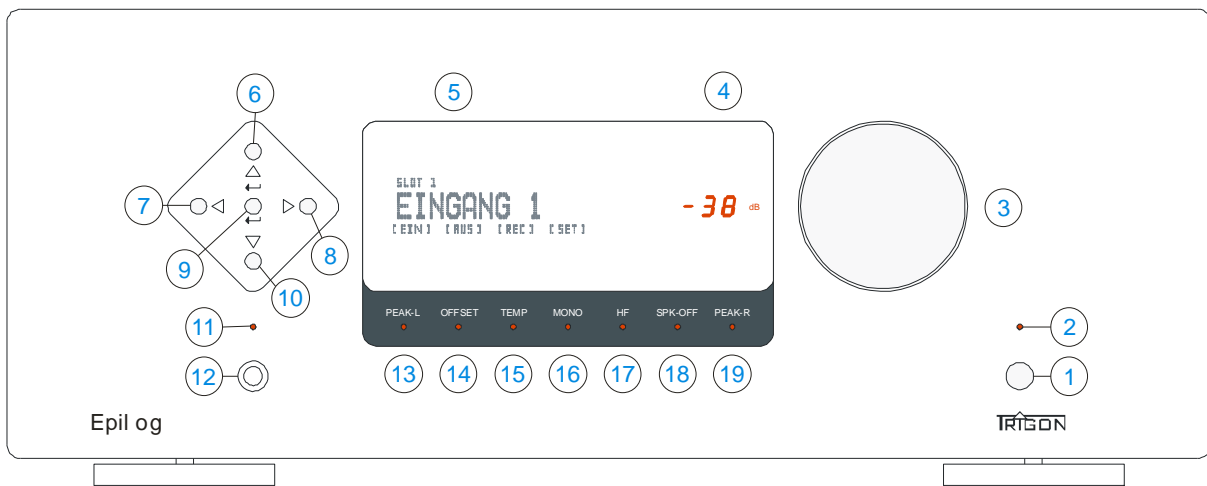

Once the devices are acclimatized, we recommend that you first get acquainted with your new **EPILOG** integrated amplifier.

The first step will be to plug the included TRIGON VOLT power cord to the power input socket (24) at the rear side and the AC plug to the mains. Now turn on the power supply with the switch (23) on the back.

The **EPILOG** is now in standby mode, and the LED (2) on the front panel of the power supply will be lit dimly.

#### EPILOG Rear View

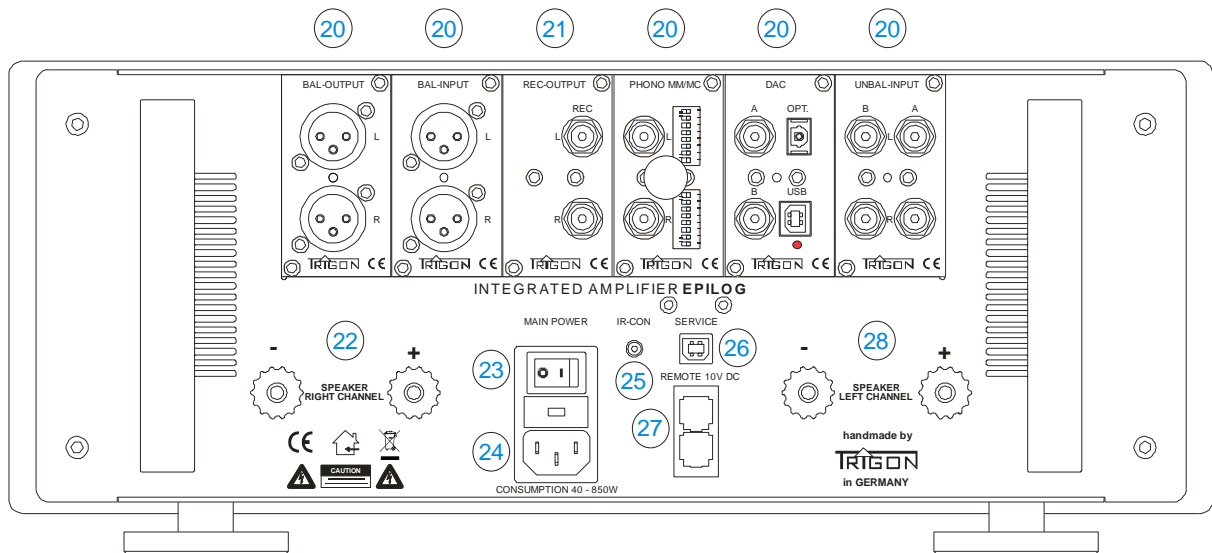

To power the **EPILOG** on completely, press the on-off button (1) on the front of **EPILOG**. LEDs (2) on the front panel flashes while a few relay click softly. Once the front panel display turns on, the **EPILOG** is ready.

Now is a good time to get familiar with the basic functions and operation of the **EPILOG** before proceeding to hook the integrated amplifier up to your system.

**CAUTION:** Before you start making any connections, you should - as always when working on the wiring - turn off the **EPILOG**, as well as the other devices in the system! Do not connect or disconnect RCA plugs to/from a UNBAL INPUT while the **EPILOG** is powered up, since with this type plugs the signal connection makes contact before the ground, which may cause a very strong buzzing sound which can under certain circumstances damage your speakers!

### 3.1 Front Panel Controls and Display

We've tried to limit the number of control elements in accordance with the motto "as much as necessary, as little as possible". An important design consideration for the **EPILOG** integrated amplifier was to keep the basic functions easy to use and intuitive – e.g. anyone is likely to associate the large knob (3) with the volume setting, the keys (7) and (8) with inputs selection, and the button (1) for turning the **EPILOG** on or off.

#### Individual Elements:

##### (1) On – Off switch

Turns the **EPILOG** on or off. When power indicator LED (2) is not lit, the standby function is not activated by switch (23) or the amp is not connected to the mains.

**NOTE:** We have the **EPILOG** equipped with a very low-power standby power supply. The power consumption is less than 1 watt in standby mode, ie you can always leave the **EPILOG** connected in standby mode to mains without completely power off using the power switch (23).

But if you once do not want to use the **EPILOG** for a longer time (holidays, etc.), you can of course turn off the power completely by switch of the mains to the switch (23).

In severe storms with lightning danger is always recommended beyond the mains is removed, ie: pull the plug!

## (2) Power indicator LED

This LED illuminates when the **EPILOG** is connected to the mains and switch (23) is switched. Now, when the on-off switch (1) is pressed, this LED flashes until the **EPILOG** is ready.

## (3) Volume knob

This knob adjusts the volume. It is an electronic pulse encoder, which forwards its signals to a microprocessor. The microprocessor controls the signals to each output module where the actual volume adjustment is made.

By pressing the volume knob the MUTE function is called, ie the volume is set to a minimum value. Displayed the MUTE function is the fact that instead of numbers for the selected volume, only four strokes are represented.



Another push on the knob or turning the volume knob raises the MUTE function off again and the previous volume level is restored.

## (4) Volume Display

This LED display indicates in dB the volume level, the value is relative to the level of the input signal.

With the remote controller **DIRECTOR** the display can be switched off if you want to have displayed only the volume level when you make a change.



The display can be turned off with the remote controller in two stages. When you first press the display button on the **DIRECTOR** the display (5) will switch off. In the second pressing, the volume indicator (4) will switch off. A new key operation switches both displays (4 and 5) on again.

#### (5) Display:

The display gives you information about the different operating states of the **EPILOG**.

It can switch off by the remote controller **DIRECTOR**, if you only want to see information when you make a change.

#### (6) Button Menu up

Use this button to navigate through the setup menu. Refer also to Chapter 3.4

#### (7) Button Input Selection

With this key you can dial down the input module. In addition, this key also navigates in the settings menu. Read more details about that in Chapter 3.4.

#### (8) Button Input Selection

With this button you can select the input module upward. In addition, this key also navigates in the settings menu. Read more details about that in Chapter 3.4.

#### (9) Button

When this button is pressed, the MONO function is turned on. Another push switches back to STEREO.

#### (10) Button Menu down

Use this button to navigate through the setup menu. See also Chapter 3.4.

**NOTE:** There will probably be in the future modules that rely on the keys (6, 7, 8, 9, 10). For details, refer then to the descriptions of the modules.

#### (11) LED PHONES

This LED is lit when the speaker relays are switched off in the menu [OFF] so you can enjoy the music through headphones without speakers.

## (12) Phones Output

Into this jack you can plug in a 6,3mm headphone. The impedance of the headphones should not be less than 32 ohms.

## (13 und 19) LED PEAK

These LEDs illuminate when the amplifier is overdriven and distorted signals are output to the speakers. Momentary flash of these LEDs can be tolerated, but if these LEDs should light up more often, so you should reduce the volume to protect both, your speakers and the amplifier.

## (14) LED OFFSET

When this LED is lit, the amplifiers output is a harmful direct current (DC offset). Epilogue then instantly disconnects the speaker from the amplifier to prevent damage to the speakers. In general, such an offset occurs at a defect in the final output stage, ie you should have to check the amplifier at the service.

## (15) LED TEMP

When this LED is lit, the permissible temperature of the output stage heat sink is exceeded. **EPILOG** switches the speaker off and LED (18) lights in addition for control. Once the heat sink has cooled down to a few degrees Celsius below the allowable temperature, the speakers are switched back on and the LEDs (15) and (18) also switch off.

## (16) LED MONO

This LED lights up when the monaural playback mode is turned on. This can be done by holding down the button (9) or by the corresponding means of appropriate key on the remote control. A further press of this button triggers the mono sound and LED (16) disappears.

## (17) LED HF

The frequency bandwidth of Epilog is very wide. Therefore, under certain circumstances the output stages can start oscillating. A not perfectly matched combination of speaker cable, crossover and loudspeaker chassis can form a resonant circuit which, in conjunction with a broadband amplifier, can built an oscillator. As these high frequencies are mostly beyond the threshold of human hearing, but overloads unnecessarily the amplifier and the tweeter of the loudspeaker, the speaker relay is switched off at such high frequencies. LED (17) and (18) lights. After a few seconds the speaker is switched on again.

But should again high-frequency oscillation occur, the speakers are switched off again and the LEDs (17) and (18) lights on again.

In general, the oscillation disappears by using a different speaker cable.

But it wants to work with the original cable, please use a RC circuit (Snubber) connected direct at the speaker terminals. This can help to prevent oscillating at the power stage.

### (18) LED SPK OFF

This LED is lit when the speaker relays are switched off. The speaker relays are switched off when the protection mechanisms mentioned above, but can also be turned off manually when you want to listen to music through headphones and to remain speakers silent. The speaker relay can be turned on and off in the menu [OFF].

When the speakers are turned off in this menu, even the LED (11) via the headphone jack (12) lights up additionally.

## 3.2 Connections on the back

Up to five modules (20) can be inserted at the back of the **EPILOG** main chassis.

The REC OUTPUT module (21) can not be removed or moved to another location because it houses the preamplifier for integrated amplifiers.

At least one input module is required to start operating the epilogue. Is this not the case, so you get a message on the display (5).

Two analogue input modules the standard feature of the **EPILOG**.

### (22 und 28) Speaker jacks

Connect the speakers to these terminals. The impedance of the connected speakers should not be less than 2 ohms.

### (23) Standby Power Switch

With this switch the mains connection is established to the **EPILOG**. However, the **EPILOG** is only by pressing the switch (1) fully turned on.

Does not press down switch (1) the **EPILOG** is in standby mode, which is also indicated by LED (2).

### (24) Mains Jack

Here the power cord is plugged. Always pay attention to the correct mains voltage. As standard, the **EPILOG** is set for a mains voltage of 230 V AC. Have been set the **EPILOG** for different voltages, then corresponding notes are (sticker) at the amp.

### (25) IR-CON Jack

An external IR controller can be connected to this jack. If the **EPILOG** is situated at a place where he can not receive infrared remote control commands, these commands can be leaked via a small external IR receiver. This receiver is available as an optional accessory.

### (26) USB-SERVICE Jack

Over time, other new modules are developed, which however, always need the right software to control. So if like to use a later newly developed module in your **EPILOG**, we created an opportunity to update the control processor with the currently valid software. Please note that you find the latest software version at our web site. There is the current software version available for download.

In the **EPILOG** SET menu is a submenu "Info" where you can get information about the currently software version of your **EPILOG**.

The required software for the update procedure and a detailed description of that procedure is also made available on our Website.

### (27) REMOTE 10V Jacks

If you have connected to the **EPILOG** another power amp or active Subwoofer, and this amp has a DC 10V remote input, an additional 10V DC signal is available at this jack to switched on and off synchronous with the **EPILOG**.

## 3.3 Quick Start Instructions

For the impatient among you who already have some experience with high-end amplifiers, here's a short guide to get to the music quickly:

- Hook up all devices
- Connect to AC mains and switch on the power switch (23) on the mains power switch.
- Turn the **EPILOG** on with the standby switch (1)
- Select source device with the input selector buttons (7) and (8)
- Set desired listening level with volume knob (3)
- Done!

### 3.4 Settings and Menus

The concept of the **EPILOG** provides an intuitive user interface. Nevertheless, this component provides useful additional features that are "hidden" in sub-menus. To fully take advantage of the **EPILOG**'S capabilities, we recommend taking the time to read the following.

#### On power-up:

During power-up cycle the **EPILOG** display will generally read as follows:



The microprocessor is checking which modules are available. There must always be at least one input module present to ensure useful configuration, otherwise you may get the following error message:



In that case please shut down and disconnect the **EPILOG** from AC mains and verify that the respective module is present and properly installed, or insert the necessary module(s).

**Make sure that at least one input module is installed!**

With at least the minimum number of modules installed, the display will read as shown in the following picture:



### Display structure:

The first line of the display indicates the number of the first occupied slot and the type of module present. As long as no specific name for an input has been set, it will be automatically designed as INPUT 1 in the second line of the display.

The third line indicates the sub-menus for the configuration of the module and general setup. E.g. Sub-menu for configuring the input modules [IN], sub-menu for the configuration of the output modules [OUT], sub-menu to select the source for record out [REC] and a sub-menu for basic settings [SET].

A red numeric LED display shows the volume level in dB.

### Basic Operation:

You can start enjoying music as soon as the unit is turned on. All that is need to select an active input and the desired volume, without having to go to any sub-menu.

The keys (7) and (8) toggle between inputs. Use the volume knob (3) to set the desired volume. That's all you need to get started.

### Menus:

To access the menus press the button (10). This will recall the previously selected menu. High-light the menu to be edited with the buttons (7) or (8). Suppose we want to edit the input setting menu [IN], we see the following message:



Use key (7) to navigate to the next menu to the right, e.g. [OUT]  
Likewise, key (8) takes you in the opposite direction (left).

### Editing the [IN] Menu:

After high-lighting the [IN] menu enter the desired menu with key (10) to get the sub-menu screen below:

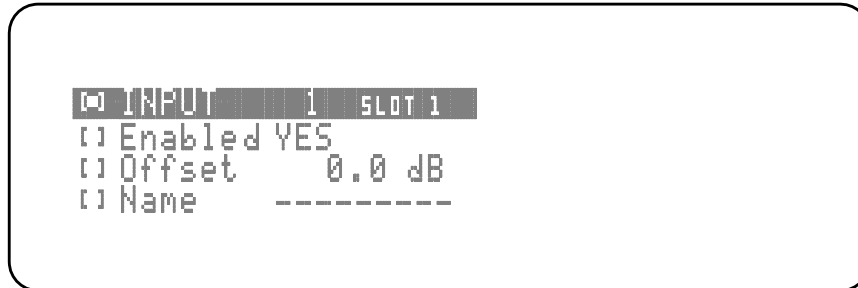

Now you are in the [IN] sub-menu, where you can edit the following settings:

- |                                  |             |       |        |
|----------------------------------|-------------|-------|--------|
| 1. Input selection               | [■] INPUT   | 1     | SLOT 1 |
| 2. Activate or de-activate input | [ ] Enabled | YES   |        |
| 3. Adjust input trim             | [ ] Offset  | 0.0   | dB     |
| 4. Name input                    | [ ] Name    | ----- |        |

#### [■] INPUT 1 SLOT 1

Use the first line to select the input to be edited with keys (7) and (8). This line also shows in which slot the selected module is installed so that you can assign the input exactly. Use button (10) to navigate to the next item.

#### [■] Enabled YES

Key (7) disables the selected input. Display: [■] Enabled NO

Key (8) enables the selected input. Display: [■] Enabled YES

#### [■] Enabled NO

This function is useful if you do not use an input. When you toggle between inputs the disabled input is skipped.

Press key (10) to select the next item.

#### [■] Offset 0.0 dB

This sub-menu allows the level setting of individual inputs to match the level of other sources to compensate for differences in playback volume when changing inputs. Note that levels can only be reduced - choose as a benchmark the weakest source and adjust for louder source devices in this menu. Maximum attenuation is -12dB, which should be sufficient in most cases.

Press key (10) again to select the next item.

[■] Name - - - - -

Select a name for the selected input from a list with keys (7) and (8). This name will be displayed when that input is selected. If no name is chosen - - - - - INPUT will be displayed.

To exit the input menu press the key (6) repeatedly, until you get back to USER mode.



Display in USER mode

Assuming that you are currently in "user mode" and you want to edit the start menu, press the key (10), and navigate using the buttons (7) and (8) to high-light the [OUT] sub-menu and get the following screen display:



Enter the [OUT] sub-menu by pressing the key (10) .The display will show:





Now you are in the [OUT] sub-menu, where they can make the following adjustments:

1. Selecting the output to be edited
2. Reverse cannels

[■] OUTPUT 1 SLOT 8  
[ ] Reverse NO

[■] OUTPUT 1 SLOT 6

On the first line select the output be edited with the keys (7) and (8). In this line you can also see the slot in which the module is installed, so that you can assign the output as desired.

[■] Reverse YES/NO

This feature allows you to swap the left and right channels with the key (7). With key (8) the channel swap will be reversed to normal. To exit the Output menu, press key (6) repeatedly until you are back in user mode.

**Editing the [REC] menu:**

Assuming that you are currently in "user mode" and you want to edit the Record menu, press the key (10). Navigate using the buttons (7) and (8) until you see the [REC] screen displayed as shown here:



Enter the [REC] sub-menu by depressing key (10)

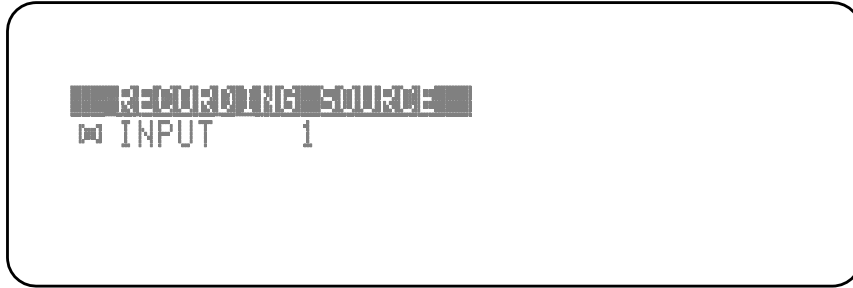

This menu allows to link a specific input to the Record Out connectors on the "UNBALANCED OUTPUT" module, when installed. This function is only possible if at least one module "UNBALANCED OUTPUT" is installed in a slot. Using the keys (7) and (7) you can select the input to be fed to the REC OUT connectors.

To return to user mode press key (6) repeatedly.

### Editing the [SET] menu:

From "user mode" navigate to the SETUP menu by pressing the key (10) and using the buttons (7) and (8) until [SET] is high-lighted.



:  
Enter the sub-menu with key (10) and see following screen displayed:

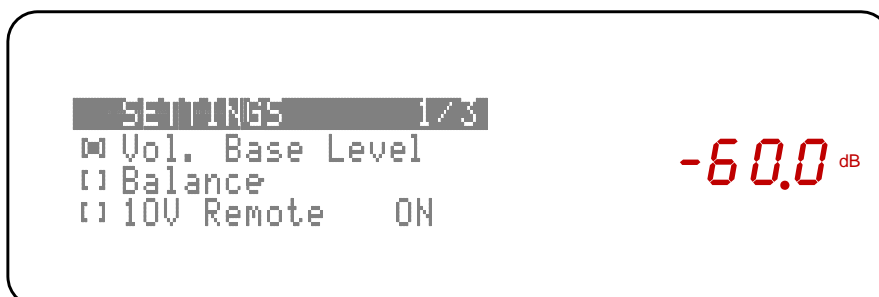

You are now in the [SET] menu, where you can make the following adjustments:

1. Speaker ON / OFF	<input checked="" type="checkbox"/> Speakers	ON
2. Set initial volume level	<input type="checkbox"/> Vol. Base Level	
3. Adjust stereo balance	<input type="checkbox"/> Balance	
4. 10V Trigger On/Off	<input type="checkbox"/> 10V Remote	
5. Adjust display brightness	<input type="checkbox"/> Brightness	
6. Select language	<input type="checkbox"/> Language	ENGLISH
7. Display status information	<input type="checkbox"/> Infos	
8. Reset to Factory Default	<input type="checkbox"/> Reset Settings	

The **[SET]** menu contains three pages.

Various sub-menus can be accessed with key (10) (down) and key (6) (up).

### **[■] Vol. Base Level**

This function allows setting the initial volume level assumed by the EPILOG upon turn-on.

This value can be set with the volume knob (3) or with keys (7) und (8). Leaving this sub-menu stores the setting.

### **[■] Balance**

Set the L/R channel balance. This value can be adjusted using the volume knob (3) with the keys (7) and (8).

### **[■] 10V Remote ON/OFF**

Enable or disable the 10V trigger output with keys (7) and (7) for remote switching of associated equipment (e.g. power amplifiers, powered speakers, etc...) equipped with this feature. The control voltage is output at the jack (27) on the rear panel.

### **[■] Brightness**

The intensity of the front panel display can be adjusted from this sub-menu. Note that the text displays (5) as only four intensity levels, whereas the volume display can be adjusted from 10% to 100%.

Use this sub-menu to adjust the display brightness. Adjust with volume knob (3), or with keys (7) and (8). The adjustment is stored when exiting this sub-menu.

### **[■] Language**

Select the display language with keys (7) and (8).

(Currently two choices are available: German (Key 7) and English (Key 8))

### **[■] Infos**

For this sub-menu press key (8) to display the currently installed software version.



```
TRIGON EPILOG V0.10
INS : 3 MODULE(S), 5 PORT(S)
OUTS: 1 MODULE(S), 1 PORT(S)
```

The currently installed Software version is displayed in the first line, after the **TRIGON** logo.

The second line [**INS**] displays the information about installed input modules and number of available inputs.

The third line [**OUTS**] displays the information about installed output modules and number of available outputs.

Pressing the key (8) again displays information about the modules installed in the individual slots.



```
SLOT 1
BALANCED INPUT MODULE
HW-REV.:00   SW-REV.: 0
1 INPUT
```

In this example: Slot 1 contains a balanced input module with hardware revision 0 and software revision 0. This module has one input.

Use keys (7) and (8) to get detailed information on every slot.

Press key (6) to exit the info sub-menu and go to the next sub-menu.

### [■] Reset settings

In the event that you want to reset the **EPILOG** to factory default settings, depress button (9) in this menu for at least 5 seconds. The **EPILOG** will display a count-down sequence and then re-boot. The **EPILOG** then reverts to normal playback mode.

To exit the SET menu depresses the key (6) repeatedly until you are back in user mode.



User mode display. The red volume display will reflect the currently selected level.

### 3.5 Unity Gain

If the epilogue should be looped in a surround setup, because the two main speakers are connected at **EPILOG**, then it may be useful to adjust the volume setting on the surround amplifier only. For this **EPILOG** has the UNITY GAIN function.

Use the arrow keys (7) and (8) to select the input to which the surround amplifier is connected. Use the arrow key (6) to enter the UNITY GAIN menu and the display shows the following picture:



Now you hold the arrow key (8) is pressed, a Countdown counts down 5 - 0 and the volume at **EPILOG** is continuously increased. When "0" is reached, loose the button (8) again and the display now shows the following:



Now the volume control is bypassed for the selected input. With button (10) you leave the UNITY GAIN menu.

To switch off UNITY GAIN again, you go back into the UNITY GAIN menu and press the arrow key (7). Now, the volume is adjustable by using the volume button (3) for this input again.

**NOTE!** Proceed extremely careful with this setting. Use this setting only with devices that also have their own volume setting. Adjust the volume of the source device in the activation of UNITY GAIN function to a "quiet" value and only then increase the volume to the desired value.

### 3.6 EPILOG and DIRECTOR remote control

The main playback functions of the **EPILOG** can be remotely controlled with the TRIGON DIRECTOR System remote control.

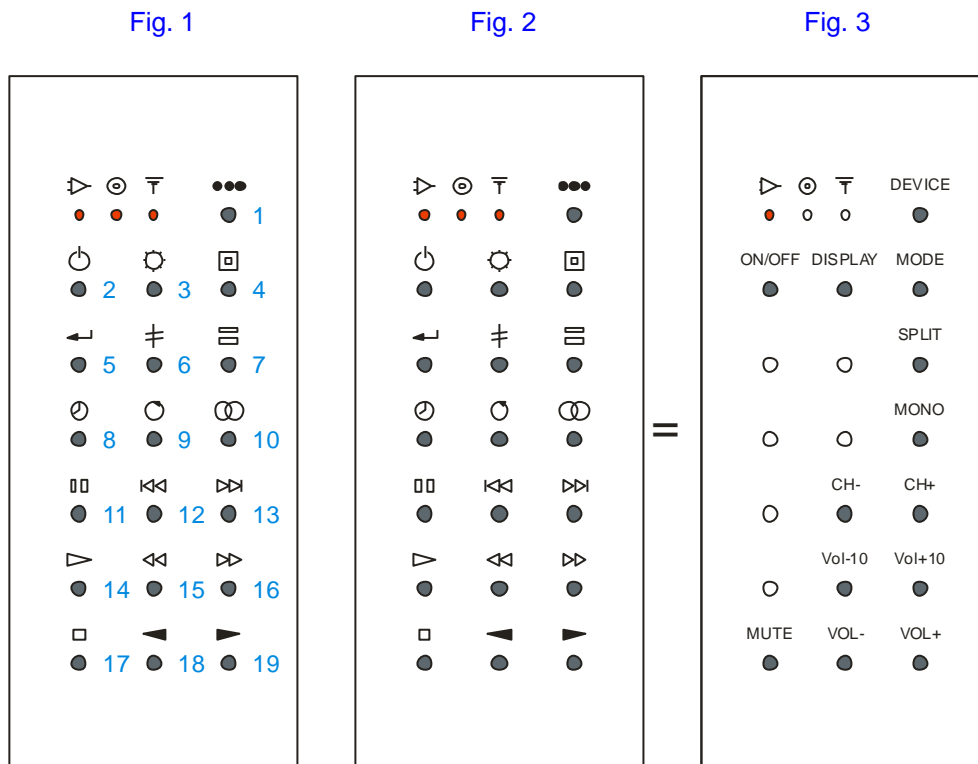

Figures 1 through 3 illustrate the layout of the remote control DIRECTOR. In Figure 3 only the keys that relate to a function of the **EPILOG** integrated amplifier are identified. The DIRECTOR is a system remote control, which can remotely control various devices from **TRIGON**. The entire keyboard can be used three fold. Individual function levels are provided for control of amplifiers, CD players and tuners. The key (1), top right, next to the device LED's, selects which type of device is controlled. To operate the **EPILOG** press the key (1) repeatedly until the first LED below the amplifier symbol [▶] flashes. Thus the "Amplifier Level" is selected and remains selected until another level is selected with key (1). Each time the key (1) is pressed the LED lights up to indicate the current is selected level.

#### Individual functions:

Key (1) selects the type of device to be controlled. The three LEDs indicate the currently selected user interface type.

Key (2) switches the **EPILOG** from/to standby mode (PSU must be powered up).

Key (3) toggles the **EPILOG 's display** on or off in steps. Pressing once turns off the text portion, pressing again turns the volume display off. Pressing a third time turns the display back on completely.

Note: All settings are retained even after turning off of **EPILOG**. However, when the display is switched off, it will come on briefly whenever an adjustment is made to the **EPILOG**. For example, when the volume is changed, the change is shown briefly before the display is switched off again. The same goes for adjustments that are usually displayed on the text display.

Key (4) recalls the SET UP menu of the **EPILOG**, just like the button {9} ENTER on the front of the unit. (See section above).

Key (5) has no function for **EPILOG**.

Key (6) has no function for **EPILOG**.

Key (7) calls up the SPLIT function if a corresponding module is installed. The split function allows devices such as equalizers, surround processors, etc. to be inserted in the signal path. If no module is installed with split function, the **EPILOG** will display an error message when this key is depressed.

Key (8) has no function for **EPILOG**

Key (9) has no function for **EPILOG**

Key (10) switches the **MONO** mode on or off. **MONO** is displayed when this mode is selected.

Key (11) has no function for **EPILOG**

Key (12) selects next input to the left.

Key (13) selects next input to the right.

Key(14) has no function for **EPILOG**

Key (15) reduces the volume **by 10 steps**.

Key (16) increases the volume **by 10 steps**

Key (17) mutes the **EPILOG**. Pressing this key again restores the previous volume setting. When **MUTE** is engaged, the volume display shows:"- - -". Changing the volume setting cancels the **MUTE** function.

Key (18) decreases the volume

Key (19) increases the volume

**TIP:** The „volume“keys (18 and 19) are independent from the device selection. Therefore, these two keys have no function for CD player or tuner.



## 4 MODULES

The entire audio range of **EPILOG** is built with modules. This way you can compose your own ideas for preamplifier. Example, if you prefer a purely symmetrical preamplifier, so you just use only symmetric input and output modules. You can also freely mix, for example, or if you need a preamp with five outputs, this is also feasible. As mentioned elsewhere, you must comply with only one condition: at least one input module and output module must be used, otherwise denied the **EPILOG** service. Currently we offer four different modules (see below). The concept of **EPILOG** is so designed that we already have more of **TRIGON** modules in the design and the fact **EPILOG** with each new module is always interesting.

For this reason, we have the manual and designed so that you get when purchasing a new module, a new chapter 4.x, you can then attach these instructions. For new modules can be of troubles, replace the control software with a new software so that the **EPILOG** this new module can also operate. Therefore, is located on the back of **EPILOG** an USB socket (26), which you can connect to a computer to update to the latest "firmware" (software mode) in the **EPILOG**. The software is provided free download at our website for available.

### 4.1 UNBAL-INPUT module

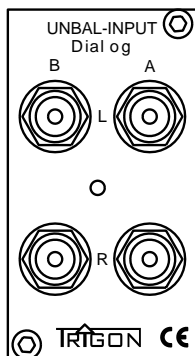

The UNBAL-INPUT module has two single-ended stereo inputs. Each input can be trimmed independently to match the level of other sources/inputs to avoid large jumps in volume when changing inputs.

### 4.2 BAL-INPUT module

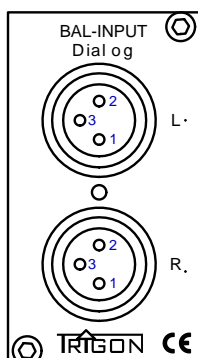

The INPUT BAL module is a balanced stereo line level input. This input can be trimmed independently to match the level of other sources/inputs to avoid large jumps in volume when changing inputs.

Pin-1 = Ground  
Pin-2 = Signal +  
Pin-3 = Signal –

Up to five **BAL-INPUT** modules can be used in one **EPILOG**.

### 4.3 UNBAL-OUTPUT module

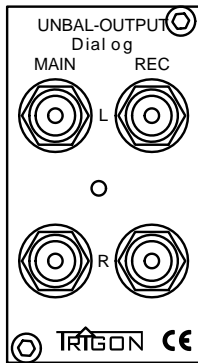

This module contains one single-ended MAIN preamplifier output with adjustable volume and a RECORD output to connect a recording device. The MAIN output is typically connected to a power amplifier or a loudspeaker amplifier with active electronics. The output impedance is 47 ohms, i.e. low enough that even long interconnect cables (up to 8 meters) can be used.

### 4.4 BAL-OUTPUT module

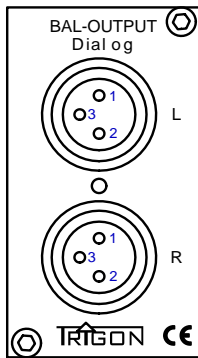

The module BAL- OUTPUT contains a balanced amplifier whose output is also capable of driving longer cables without significant quality loss. This output is connected to the balanced input of a power amplifier or active speaker. Balanced connections have the advantage that noise and interference with the signal are effectively suppressed.

A maximum of four BAL OUTPUT modules can be used in one **EPILOG** amplifier. The volume of all output modules is controlled by the master volume control designated in the SET menu. However, it is possible to trim the relative output level for each module. The individual outputs are electronically separated from each other.

## 4.6 PHONO Module

The PHONO module can be connected to a turntable with MM or MC pickup. The impedance matching of the pickup is made on the rear of the module by subminiature switches. Please refer to the tables [A] and [B] for the adjustable values.

Also, the gain of the PHONO module must be adapted to the used pickup. This setting is made on the front of the **EPILOG**. Two PHONO modules can be installed in the **EPILOG**.

### 4.6.1 The Necessary Software

To operate the PHONO module, the **EPILOG** requires the firmware with the version V0.10 or higher. If the installed firmware is "older" than V0.10 (the number is less than 0.10), so you need only perform an update. (See section 4.1)

### 4.6.2 The connectors on the back

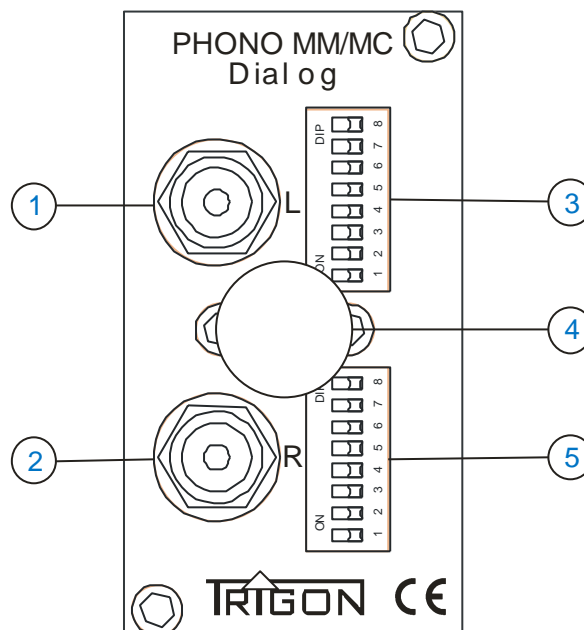

To the RCA connectors [1] and [2] the record player are connected. Normally turntables have a separate ground wire. This cable must be connected to the screw terminal [4] (Ground socket).

The two switch banks [3] and [5] are used to separate channel impedance matching of the connected pickup. Each switch bank has 2 switches for capacitive adaptation of a MM pickup and 6 switches for adjusting a MC pickup.

### 4.6.3 The settings and menus

The module PHONO can be optimally adjusted to the used pickup of the turntable. The value can be taken from the operating instructions manual of the pickup. The available adjustment values are listed in Tables [A] and [B].

Table [A] shows the values for a capacitive adjustment, as is required for MM cartridges. Table [B] shows the values for impedance matching, as is required for MC cartridges.

### MM-Cartridges:

The switches S1 and S2 are for adapting to MM cartridges. S3 to S8 are normally not necessary for MM and are switched off.

#### 4.6.4 Table A of the switch settings for the input capacitance

S1	S2	S3	S4	S5	S6	S7	S8	Input Capacitance	Input Impedance Ohm
0	1	0	0	0	0	0	0	47pF	47000,0
1	0	0	0	0	0	0	0	100pF	47000,0
1	1	0	0	0	0	0	0	147pF	47000,0

The input capacitance without connected capacity of the module PHONO is 60 - 100pF. Each capacitor that is connected must be added to the input capacitance.

The interconnection cable capacitance and the capacitance of the arm tube of the turntable have to be added, too. In this way, often more than 200pF - 300pF capacity is added without any additional capacitors.

Should be noted, however, that deviations from the recommended cartridge manufacturer adaptive capacity, on the order 20-30% are acceptable, as in the production of pickups often similar tolerances occur.

**MC-Cartridges:** The switches S1 and S2 have no meaning in MC and should remain in the neutral position. Switches S3 to S8, are matching the impedance of a connected MC system. The value can be taken from the operating instructions manual of the pickup. Table [B] shows all the possible values for this module and associated switch positions.

It is also possible to set the switches like you want, because it may happen that different input impedance sounds better than the proposed values. Consequently, quite a few pick-up manufacturers also give a very wide range of adjustment for your pickup to (eg 200 Ohm to 47 KOhm). So try out different settings and set the value that comes closest to your ideal sound. Nothing can go wrong. Please set the volume low every time you do a switching process between the Switches S1 to S8 to avoid any switching noises.

#### 4.6.5 Table B Switch settings for the input resistors

100p	47p	1800	1000	470	220	100	47	
S1	S2	S3	S4	S5	S6	S7	S8	Input resistance calculated in Ohm
0	0	0	0	0	0	0	0	47000,0
0	0	1	0	0	0	0	0	1733,6
0	0	0	1	0	0	0	0	979,2
0	0	1	1	0	0	0	0	634,2
0	0	0	0	1	0	0	0	465,3
0	0	1	0	1	0	0	0	369,8
0	0	0	1	1	0	0	0	317,6
0	0	1	1	1	0	0	0	269,9
0	0	0	0	0	1	0	0	219,0
0	0	1	0	0	1	0	0	195,2
0	0	0	1	0	1	0	0	179,6
0	0	1	1	0	1	0	0	163,3
0	0	0	0	1	1	0	0	149,4
0	0	1	0	1	1	0	0	137,9
0	0	0	1	1	1	0	0	130,0
0	0	1	1	1	1	0	0	121,2
0	0	0	0	0	0	1	0	99,8
0	0	1	0	0	0	1	0	94,5
0	0	0	1	0	0	1	0	90,7
0	0	1	1	0	0	1	0	86,4
0	0	0	0	1	0	1	0	82,3
0	0	1	0	1	0	1	0	78,7
0	0	0	1	1	0	1	0	76,1
0	0	1	1	1	0	1	0	73,0
0	0	0	0	0	1	1	0	68,6
0	0	1	0	0	1	1	0	66,1
0	0	0	1	0	1	1	0	64,2
0	0	1	1	0	1	1	0	62,0
0	0	0	0	1	1	1	0	59,9
0	0	1	0	1	1	1	0	58,0
0	0	0	1	1	1	1	0	56,5
0	0	1	1	1	1	1	0	54,8
0	0	0	0	0	0	0	1	47,0
0	0	1	0	0	0	0	1	45,8
0	0	0	1	0	0	0	1	44,8
0	0	1	1	0	0	0	1	43,8
0	0	0	0	1	0	0	1	42,7
0	0	1	0	1	0	0	1	41,7
0	0	0	1	1	0	0	1	40,9
0	0	1	1	1	0	0	1	40,0
0	0	0	0	0	1	0	1	38,7
0	0	1	0	0	1	0	1	37,9
0	0	0	1	0	1	0	1	37,3
0	0	1	1	0	1	0	1	36,5
0	0	0	0	1	1	0	1	35,8
0	0	1	0	1	1	0	1	35,1
0	0	0	1	1	1	0	1	34,5
0	0	1	1	1	1	0	1	33,9
0	0	0	0	0	0	1	1	32,0
0	0	1	0	0	0	1	1	31,4
0	0	0	1	0	0	1	1	31,0
0	0	1	1	0	0	1	1	30,4
0	0	0	0	1	0	1	1	29,9
0	0	1	0	1	0	1	1	29,4
0	0	0	1	1	0	1	1	29,0
0	0	1	1	1	0	1	1	28,6
0	0	0	0	0	1	1	1	27,9
0	0	1	0	0	1	1	1	27,5
0	0	0	1	0	1	1	1	27,1
0	0	1	1	0	1	1	1	26,7
0	0	0	0	1	1	1	1	26,3
0	0	1	0	1	1	1	1	26,0
0	0	0	1	1	1	1	1	25,7
0	0	1	1	1	1	1	1	25,3

A 1 means switch is set to ON  
A 0 means switch is set to OFF

Because different pickups provide different output voltages, it is necessary to adjust the gain of the Phono module to the respective pickup. To access the menu for the gain setting, you select the Phono module with the input selector buttons and then press the button (10) of the **EPILOG**. Now you should see the following screen.

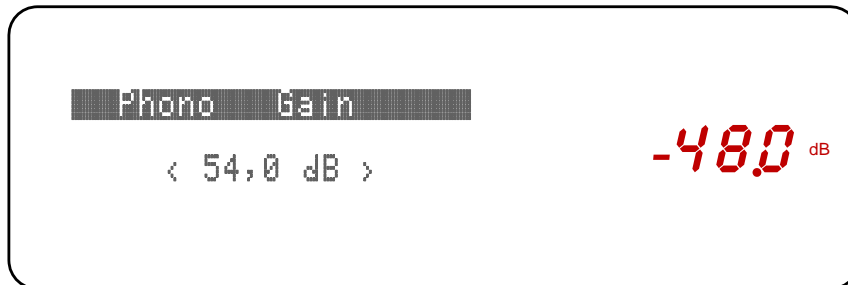

Display menu Phono gain (54dB here are just set)

The gain adjustment is on the **EPILOG** with the arrow keys (7) and (8). Table (C) also provides you again a few benchmarks.

In the User s instruction usually the value of the output voltage of the pickup is specified. Select a value for the gain, where the output voltage of your system is the closest.

Press button (10) on the **EPILOG** you leave the Gain menu.

#### 4.6.6 Table [C] Gain Adjustment

Gain In dB	For cartridges with these levels
42	4mV
47,5	2,1mv
51,3	1,4mV
54	1,0mV
55	0,89mV
56,5	0,75mV
58,5	0,60mV
59,5	0,53mV
62,5	0,38mV
63	0,35mV
64	0,32mV
64,5	0,3mV
65	0,29mV
65,5	0,28mV
66	0,25mV
66,5	0.24mV

With the settings specified in table [C] you get a preamp output voltage of 500 mV. Cartridge manufacturer often offer the output voltage of their pickups as follows:

Output voltage = 0,4mV at 3,54cm/s

The normalized output voltage usually refers to a reference of 5.6 cm / s. In our case, therefore, results in the output voltage to:

$$V_{out} = \frac{0,4mV}{3.54cm/s} * 5,6cm/s$$

Thus, there is an output voltage of about 0.63 mV, ie. you should set a gain of about 58.5 dB.

## 4.6.7 Technical Data PHONO Module

Input	: 2x Cinch
Distortion (THD + N)	: < 0.03%
Frequency response	: 20 Hz – 20 kHz (+-1dB)
S/N	: -86 dB
Weight	: ca. 350g
Dimensions	: 40 x 73,5 x 173,5 mm ( BxHxT )

## 4.7. DAC Modul

Four digital source devices can be connected to the DAC module. Use the arrow keys (7) and (8) on the front panel of the **EPILOG** to choose the input. Following inputs are available:

2x Coax (Cinch) SPDIF  
1x Toslink  
1x USB

If this is four digital inputs are not enough, further DAC Modules can be installed.

Five DAC modules are possible so that you get 20 digital inputs!

The DAC module translates the digital music information into analog audio signals that can then be processed in the **EPILOG**. The maximum resolution of the DAC module is 24 bits and 192 kHz (compared to CD players have a resolution of 16 bits and 44.1 kHz). The maximum resolution of the USB input is 24 bits at 96 kHz. The DAC module automatically adjusts to the required resolution.

All inputs are galvanically isolated, i.e. the DAC is connected to an input transformer or optically coupled to the source equipment. In this way, any hum are (keyword ground loop) effectively prevented.

To avoid damage to the **EPILOG** to your system, please connect only digital source devices to the DAC module! The module can not handle analog signals at the inputs, and also the source device could suffer damage.

### 4.7.1 The necessary Software

To drive the DAC module **EPILOG** needs firmware version V0.10 or higher. If the installed firmware is "older" than V0.10 (the number is less than 0.10), so you need only perform an update. (See section 4.1)

### 4.7.2 The connectors on the back

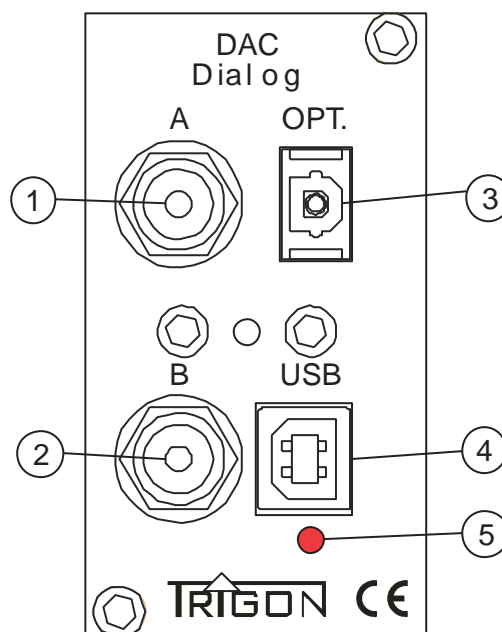

#### [1] and [2] A and B

The RCA jacks A (1) and B (2) are the two coaxial SPDIF inputs. Here, all devices can be connected, which have a standards-compliant SPDIF output.

#### [3] OPT.

To the optical fiber input OPT. (3) can be connected to a source device with a Toslink optical cable. The data format is also SPDIF.

#### [4] USB

To the USB port (4) a computer can be connected. If the computer is the first time connected to the epilogue, it takes a moment for the computer to install the required



default drivers. The computer treats the **EPILOG** now as a separate USB sound card. The maximum resolution is 24-bit 96 KHz at this entry.

### 4.7.3 The settings and menus

As described in detail under 3.5.1, the names of the inputs can be set individually. In the initial state (factory setting), the coax digital inputs with the names shown in the following images A, B coax, and USB Opt appear. The gain of each input is individual adjustable. This level adjustment is behind the DAC in the analog domain. Please note that there is not the possibility of an independent playback / record function on the digital inputs.



Display when the coax input A is selected.



Display when the coax input B is selected.



Display when the optical input is selected.



Display when the USB input is selected.

#### 4.7.4 Technical Data DAC Module

Inputs	: 2x Cinch SPDIF, 1x Toslink, 1x USB
Distortion (THD + N)	: < 0.03%
Frequency response (analogue)	: 20 Hz – 20 kHz (+-1dB)
Signal / Noise ratio	: -106 dB
Weight	: 350g
Dimensions	: 40 x 73 x 173 mm ( BxHxT )

## 5 What if...

This chapter is to help you troubleshooting, locating and eliminating small problems.

### 5.1 ... nothing happens?

- Is the power cord properly connected? - *verify that everything is plugged in correctly.*
- Is the AC outlets live, or was a breaker tripped? - *check electric panel.*
- Is the main power switch on the back (8) on? – *Check main power switch.*
- Is the micro-fuse blown? – *replace micro-fuse with identical type/value. If fuse blows again send the unit in for service.*

### 5.2 ... there's no sound?

- Correct input selected? - *verify source selection.*
- Does the source output a signal? –

- Was the unit exposed to a static electricity discharge? *This can happen in very dry environment, especially during the winter heating season. A static discharge can cause the micro processor to crash. Shut down and disconnect the unit from the AC mains for approx. 60 seconds and re-start the system. Generally the device will operate normally.*

### **5.3 ... it hums?**

Are all cable connections secured? - *Verify cabling.*

Sometimes multiple earth connections can cause so-called ground loops. Troubleshooting this requires some experience. We recommend contacting your dealer for help.

It only hums when a TV or video recorder is connected – *these devices are connected to an antenna or a cable feed, which are grounded themselves, possibly causing a ground loop. Try using a „ground breaker“ - These are readily available from good specialty dealers.*

### **5.3 ... errors made by man or machine?**

The **EPILOG** has been designed to be used under normal operating conditions as a high quality audio amplifier for domestic use. Unrealistic test such as listening to a un-used input at high volume will result in noise coming from the speakers, which is perfectly normal. Rapid and repeated pressing of random buttons on the unit itself or the remote control is not part of the purpose for which a high quality audio component has been designed. It is rather ment to provide many years of good sound and enjoyment, which it will do when it is used the way it was intended in the first place.

## 6 Specifications

<b>Inputs</b>	: depending on the modules used
<b>Input Impedance</b>	: typically 47 KOhm
<b>Input Sensitivity</b>	: depending on the modules used
<b>Output Power</b>	: 2x 200 / 330 W at 8/4 Ohm
<b>Damping Factor</b>	: >100 (based on 8 Ohm 1KHz)
<b>Distortion ( THD + N)</b>	: < 0.02%
<b>Outputs</b>	: 1x Speaker, 1x headphones, Symmetrical and Asymmetrical Line Out depending on the modules installed, 1x Record
<b>Frequency response</b>	: normally 2 Hz – 200 kHz (-3dB)
<b>Signal / Noise</b>	: -94 dB based on 1 Watt at 4 Ohm
<b>Weight</b>	: 25Kg
<b>Dimensions</b>	: 440 x 180 x 405 mm (WxHxD)

12.2019 subject to change

Development and assembly:

### **TRIGON ELEKTRONIK GMBH**

Crumbacher Str. 60  
D-34277 Fuldabrück - Bergshausen  
Germany

Tel. +49 (0) 561/20753880  
Fax +49 (0) 561/20753888

e-mail: [trigon@trigon-audio.de](mailto:trigon@trigon-audio.de)  
web: [www.trigon-audio.de](http://www.trigon-audio.de)